



# FC6 series

Photoelectric fork for objects detection with regulation



## features

- Simple and accurate adjustment manually by +/- buttons
- Infrared emission; LASER emission class 1
- Metal housing
- Light/Dark switching, selectable by button
- Minimum size object detection 0,2 mm (FC6I) and 0,05 mm (FC6L)
- -20...+60 °C temperature range
- M8 connectors (4pins): PNP/NPN, LO/DO
- Switching frequency 10 kHz

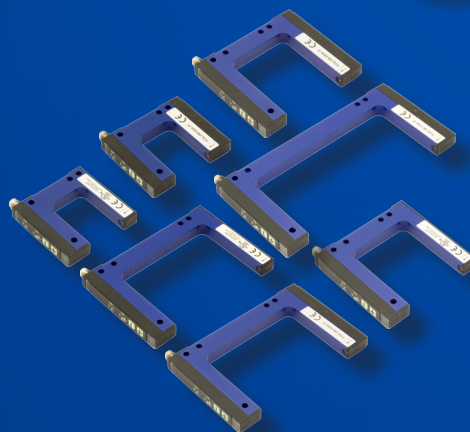

## web contents



- Application notes
- Photos
- Catalogue / Manuals



fork for objects detection with regulation

## code description

FC6 L / 0 B - 03 04 - 1 F

series	FC6	Fork for objects
emission	L	LASER emission (670 nm)
	I	LED Infrared emission
output	0	State (LO/DO) selectable
output	B	Digital output (NPN/PNP)
width slit detection	M2	Width slit detection 2 mm
	M5	Width slit detection 5 mm
	01	Width slit detection 15 mm
	03	Width slit detection 30 mm
	05	Width slit detection 50 mm
	08	Width slit detection 80 mm
	12	Width slit detection 120 mm
depth	04	Depth slit detection 42 mm
	06	Depth slit detection 59 mm
	10	Depth slit detection 95 mm
housing	1	Metal housing - Aluminum
plug	F	Plug M8 4 pin

## available models

fork for objects detection  
with regulation

supply	installation	width (mm)	depth (mm)	FC6I, NPN - PNP, LO/DO selectable	FC6L, NPN - PNP, LO/DO selectable
12...24 Vdc	M8 4 pins	2	42	FC6I/0B-M204-1F	FC6L/0B-M204-1F
			59	FC6I/0B-M206-1F	FC6L/0B-M206-1F
			95	FC6I/0B-M210-1F	FC6L/0B-M210-1F
		5	42	FC6I/0B-M504-1F	FC6L/0B-M504-1F
			59	FC6I/0B-M506-1F	FC6L/0B-M506-1F
			95	FC6I/0B-M510-1F	FC6L/0B-M510-1F
		15	42	FC6I/0B-0104-1F	FC6L/0B-0104-1F
			59	FC6I/0B-0106-1F	FC6L/0B-0106-1F
			95	FC6I/0B-0110-1F	FC6L/0B-0110-1F
		30	42	FC6I/0B-0304-1F	FC6L/0B-0304-1F
			59	FC6I/0B-0306-1F	FC6L/0B-0306-1F
			95	FC6I/0B-0310-1F	FC6L/0B-0310-1F
		50	42	FC6I/0B-0504-1F	FC6L/0B-0504-1F
			59	FC6I/0B-0506-1F	FC6L/0B-0506-1F
			95	FC6I/0B-0510-1F	FC6L/0B-0510-1F
		80	42	FC6I/0B-0804-1F	FC6L/0B-0804-1F
			59	FC6I/0B-0806-1F	FC6L/0B-0806-1F
			95	FC6I/0B-0810-1F	FC6L/0B-0810-1F
		120	42	FC6I/0B-1204-1F	FC6L/0B-1204-1F
			59	FC6I/0B-1206-1F	FC6L/0B-1206-1F
			95	FC6I/0B-1210-1F	FC6L/0B-1210-1F

## technical specification

	FC6L/**_**_**	FC6I/**_**_**
	 2...120 mm	
nominal sensing distance	2...120 mm	
minimum detectable object	0.05 mm	0.2 mm
emission	red LASER 670 nm, modulated, class 1	infrared LED, modulated
external lighth interference	10,000 lux (5,000 lux incandescent lamp)	
operating voltage	12 ... 24 Vdc (with protection against reverse polarity)	
max ripple content	10%	
no-load supply current	40 mA	
load current	100 mA	
output voltage drop	≤ 2 V @ IL = 100 mA	
switching frequency	10 kHz	
power supply protections	inverse-polarity protected short-circuit output protected	
temperature range	- 20 ... + 50 °C	- 20 ... + 60 °C
storage temperature	- 30 ... + 80 °C	
protection degree	IP65 (EN60529)	
housing material	painted aluminium and polyamide/glass	
plug	M8 4 pin	
weight (approximate)	55...128 g	



## PNP/NPN selectable output

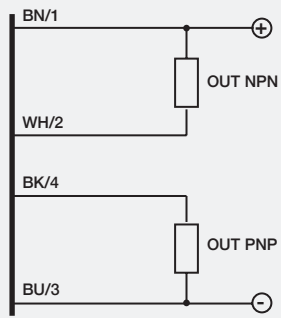

- BN brown
- BU blue
- BK black
- WH white
- PK pink
- GY gray

## plug

### M8 FC6L/\*\*\_\*\*\_\*\* FC6I/\*\*\_\*\*\_\*\*

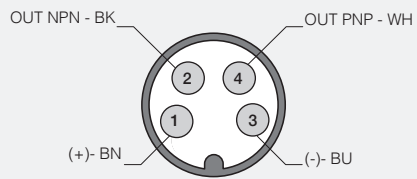





FC6L width > 30mm

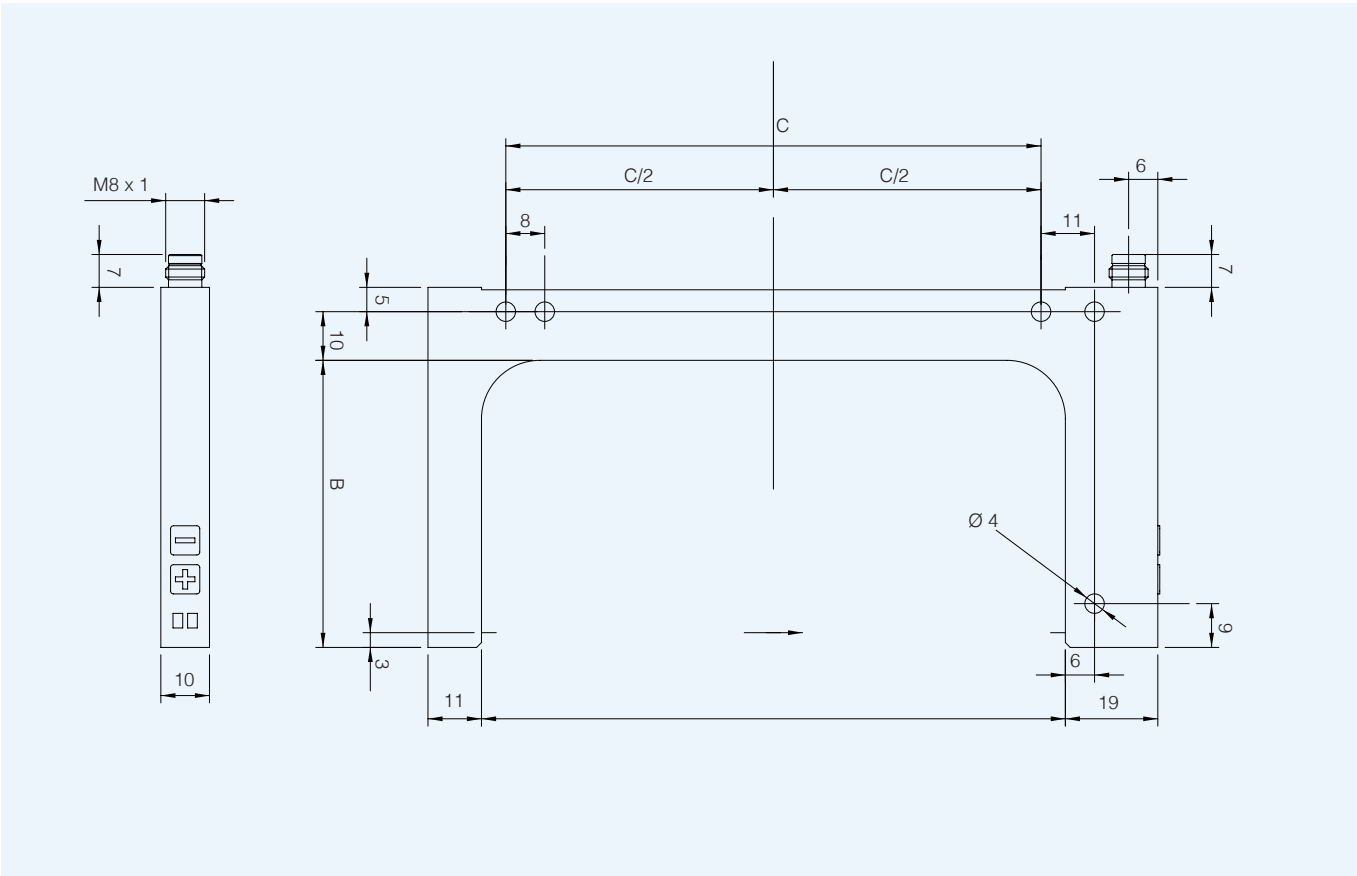

FC6L width ≤ 30mm

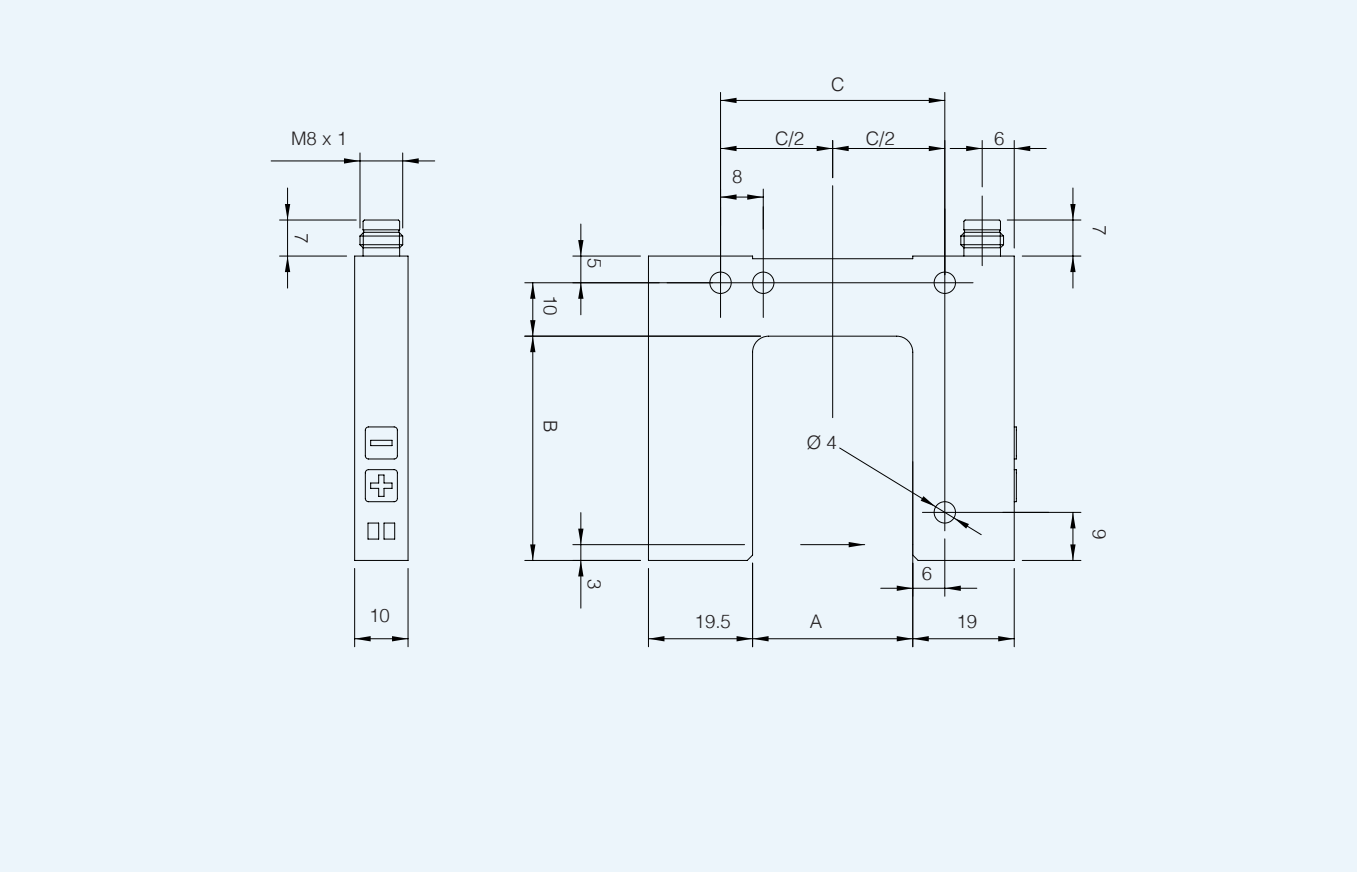

FC6L width > 30mm

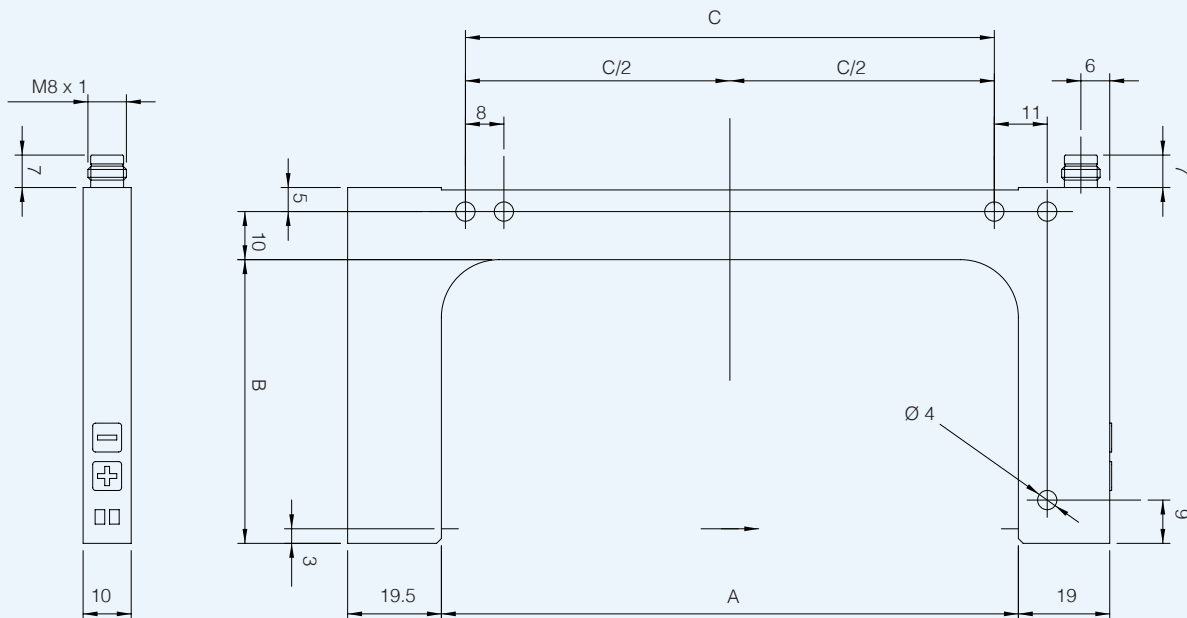

models	A width (mm)	B depth (mm)	C	models	A width (mm)	B depth (mm)	C
FC6*/0B-M204-**	2	42	14	FC6*/0B-0504-**	50	42	40
FC6*/0B-M206-**		59	14	FC6*/0B-0506-**		59	40
FC6*/0B-M210-**		95	14	FC6*/0B-0510-**		95	40
FC6*/0B-M504-**	5	42	14	FC6*/0B-0804-**	80	42	70
FC6*/0B-M506-**		59	14	FC6*/0B-0806-**		59	70
FC6*/0B-M510-**		95	14	FC6*/0B-0810-**		95	70
FC6*/0B-0104-**	15	42	27	FC6*/0B-1204-**	120	42	110
FC6*/0B-0106-**		59	27	FC6*/0B-1206-**		59	110
FC6*/0B-0110-**		95	27	FC6*/0B-1210-**		95	110
FC6*/0B-0304-**	30	42	42				
FC6*/0B-0306-**		59	42				
FC6*/0B-0310-**		95	42				